



CF-6V1.3



CAREFREE RECHARGEABLE - LEAD ACID

Product Name	Sealed Lead Acid(SLA)
Technology	AGM

APPLICATIONS

Airports; Emergency; Industrial; Medical;
Military; Navigation; Railroad Signals;
Residential; Security; Specialized Products;
UPS/Lighting

PERFORMANCE SPECIFICATIONS

Voltage (Volts)	6
Capacity (Amp-Hours)	1.3

DIMENSIONS AND WEIGHT

Width/Diameter (Inches)	0.94
Length/Depth (Inches)	3.82
Height/Thickness (Inches)	2.05
Weight (Pounds)	0.68

PRODUCT NOTES

Terminal is tin plated brass, ABS case material

SPECIFICATIONS CF-6V1.3

Nominal Voltage 6V
 Nominal Capacity at 77°F (25°C) Voltage readings are per cell
 20 Hour Rate (0.06 amps to 1.75 volts) 1.2 ampere hours
 10 Hour Rate (0.11 amps to 1.75 volts) 1.1 ampere hours
 5 Hour Rate (0.21 amps to 1.75 volts) 1.05 ampere hours
 1 Hour Rate (0.82 amps to 1.60 volts) 0.82 ampere hours
 1/2 Hour Rate (1.5 amps to 1.60 volts) 0.75 ampere hours
 Max. Physical Size
 Length 3.82 inches (97mm)
 Width 0.94 inches (24mm)
 Height (excluding terminals) 2.05 inches (52mm)
 Height (including terminals) 2.28 inches (58mm)
 Weight 0.68 lbs (0.31kg)
 Energy Density
 (20 Hour Rate) 1.06 watt hrs/cu in
 (20 Hour Rate) 11.47 watt hrs/lbs
 Operating Temperature Range
 Discharge -60°F to +140°F (-51°C to +60°C)
 Charge 0°F to +120°F (-18°C to +49°C)
 Recharging Methods:
 Float Charging: Constant Potential Source of 6.8 to 6.9 volts continuously.
 Routine Charging: Constant Potential Source of 7.25 to 7.45 volts with a charging current of 0.48 ampere maximum.
 Terminal: Standard is tin plated brass, positive terminal is 0.030 stock by 0.187 wide, negative terminal is 0.030 stock by 0.187 wide, mates with Amp Faston series or equal.
 Case Material: ABS



PRODUCT SCHEMATICS

SPECIFICATIONS CF-12V1.3

Nominal Voltage 12V
 Nominal Capacity at 77°F (25°C) Voltage readings are per cell
 20 Hour Rate (0.06 amps to 1.75 volts) 1.2 ampere hours
 10 Hour Rate (0.11 amps to 1.75 volts) 1.1 ampere hours
 5 Hour Rate (0.21 amps to 1.75 volts) 1.05 ampere hours
 1 Hour Rate (0.82 amps to 1.60 volts) 0.82 ampere hours
 1/2 Hour Rate (1.5 amps to 1.60 volts) 0.75 ampere hours
 Max. Physical Size:
 Length 3.82 inches (97mm)
 Width 1.69 inches (43mm)
 Height (excluding terminals) 2.05 inches (52mm)
 Height (including terminals) 2.26 inches (57mm)
 Weight 1.25 lbs (0.57kg)
 Energy Density
 (20 Hour Rate) 1.07 watt hrs/cu in
 (20 Hour Rate) 12.48 watt hrs/lbs
 Operating Temperature Range:
 Discharge -60°F to +140°F (-51°C to +60°C)
 Charge 0°F to +120°F (-18°C to +49°C)
 Recharging Methods:
 Float Charging: Constant Potential Source of 13.5 to 13.8 volts continuously.
 Routine Charging: Constant Potential Source of 14.4 to 15.0 volts with a charging current of 0.43 ampere maximum.
 Terminal: Standard is tin plated brass, positive terminal is 0.030 stock x 0.187 wide, negative terminal is 0.030 stock by 0.187 wide, mates with Amp Faston series or equal.
 Case Material: ABS

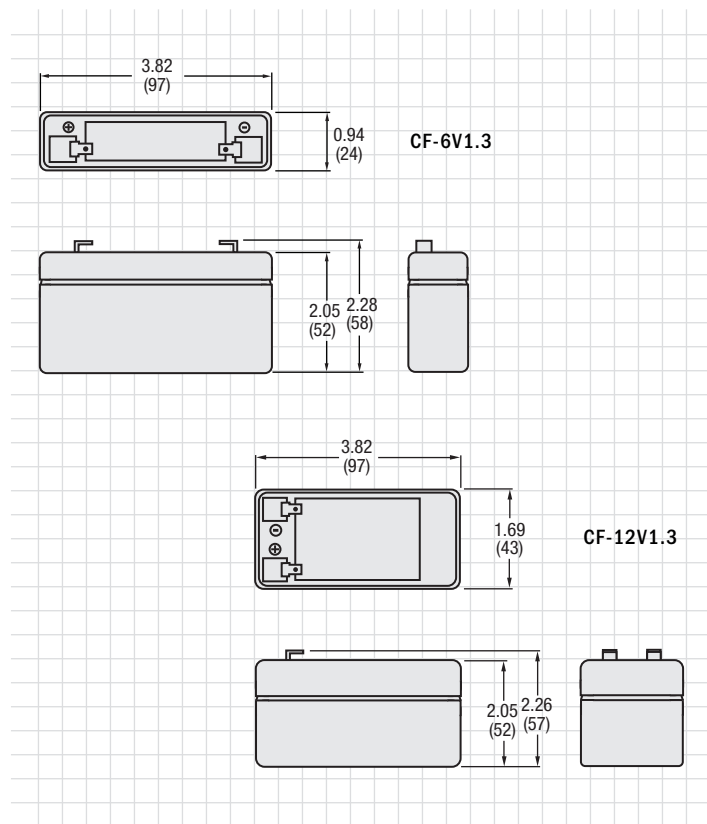

Above data are average values which can be obtained within 3 charge/discharge cycles. These are not minimum values.